

Live  Wire



horiz **AL**

ALUMINIUM GATE COLLECTION

“One Gate for Life”

CONTEMPORARY

WOODGRAIN *Collection*

With privacy being an important factor for many of our customers, our close-boarded "Contemporary" collection, available in a range of designs & finishes, is an ideal choice for many, with every gate within this brochure being virtually maintenance-free.



LIMNOS - WALNUT TEXTURE

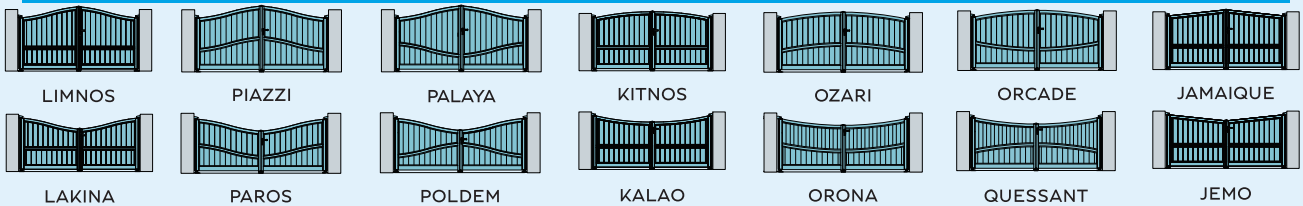

MANY OTHER MODELS AVAILABLE



LIMNOS - RUSTIC OAK TEXTURE



LIMNOS - GOLDEN OAK

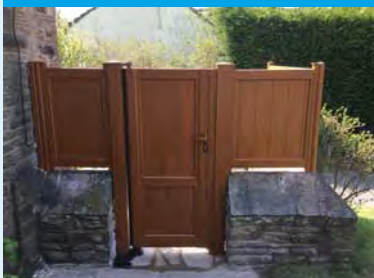

JABAL - GOLDEN OAK

THE WOODGRAIN EFFECTS



Golden Oak



Golden Oak Texture



Rustic Oak Texture

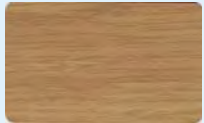

Irish Oak Texture



Walnut Texture



JABAL - GOLDEN OAK TEXTURE



JABAL - GOLDEN OAK



LIMNOS - WALNUT TEXTURE

CONTEMPORARY

CONTEMPORARY PAINTED *Collection*

As an alternative to an authentic woodgrain look & feel, we also offer this range of gates in standard & non-standard colours, which may be more suited to the style of your property or to match garage doors, window frames & other household features.



LIMNOS - CHEVRON BOARDS

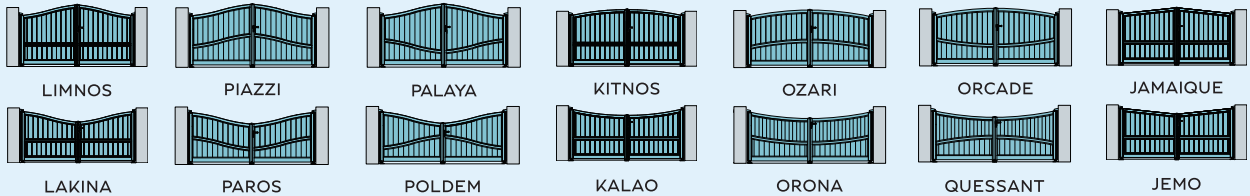

MANY OTHER MODELS AVAILABLE



MAHE - SLIDING GATE



PIAZZI - SWING GATES



MYKONOS - SWING GATES

COLOURS AVAILABLE AS STANDARD
(THE ENTIRE RAL CHART IS AVAILABLE AT A SLIGHTLY HIGHER COST)

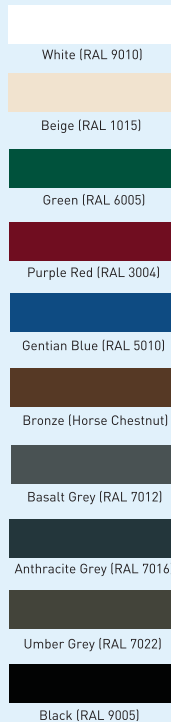

LIMNOS - SWING GATES



LIMNOS - DIAGONAL BOARDS



JABAL - SLIDING GATE

CONTEMPORARY

WOODGRAIN *Collection*

With a little less privacy in mind, this stylish “part-open” collection is very popular, allowing views into your property as well as out to the road. We offer all of these in the same woodgrain effects & can create matching fences & side gates also.



RODRIGUES - GOLDEN OAK



RODRIGUES



IKARIA



REUNION



HALVO



GOZO



GARITA



RHODES



IBIZA



ROSCANA



HITRA



GANAK



SERAM

MANY OTHER MODELS AVAILABLE



RODRIGUES - GOLDEN OAK TEXTURE



IBIZA - GOLDEN OAK



REUNION - GOLDEN OAK TEXTURE

THE WOODGRAIN EFFECTS



Golden Oak

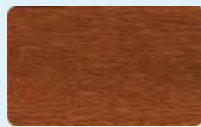

Golden Oak Texture

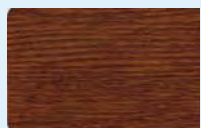

Rustic Oak Texture

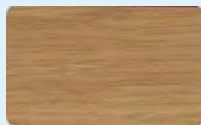

Irish Oak Texture



Walnut Texture



TOBAGO - IRISH OAK TEXTURE



IKARIA - WALNUT TEXTURE

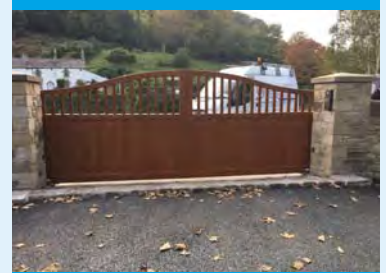

RODRIGUES - RUSTIC OAK TEXTURE

CONTEMPORARY

CONTEMPORARY PAINTED *Collection*

Again, with an alternative option to the woodgrain finish, we offer these as painted products allowing you to match the colour of other architectural features throughout your property, such as window frames, doors & even fascia boards. Side gates & fences can be matched throughout the range also.



GARITA SWING GATES & RAILINGS



RODRIGUES



IKARIA



REUNION



HALVO



GOZO



GARITA



RHODES



IBIZA



ROSCANA



HITRA



GANAK



SERAM

MANY OTHER MODELS AVAILABLE



RODRIGUES - SWING GATES



SOLOR - SWING GATES

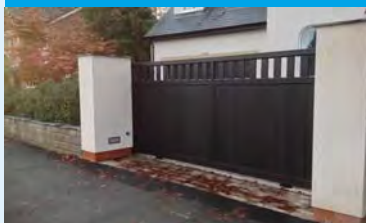

SERAM - SLIDING GATE

COLOURS AVAILABLE AS STANDARD
(THE ENTIRE RAL CHART IS AVAILABLE AT A SLIGHTLY HIGHER COST)

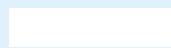

White (RAL 9010)

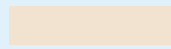

Beige (RAL 1015)



Green (RAL 6005)



Purple Red (RAL 3004)



Gentian Blue (RAL 5010)

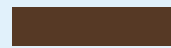

Bronze (Horse Chestnut)

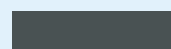

Basalt Grey (RAL 7012)

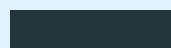

Anthracite Grey (RAL 7016)



Umber Grey (RAL 7022)



Black (RAL 9005)



HITRA - SWING GATES



GARITA - SLIDING GATE



GARITA - FENCING

TRADITIONAL

TRADITIONAL *Collection*

This collection offers a wide choice of swing & sliding gates, along with matching railings & smaller gates. Offering a vast choice of options & styles, all of this range is suited to many traditional style properties without having the disadvantages of corrosion & maintenance.



NESLIA - SWING GATES



MONTIA - SWING GATES

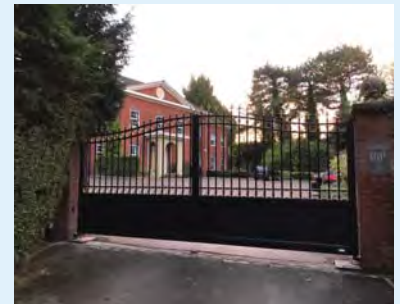
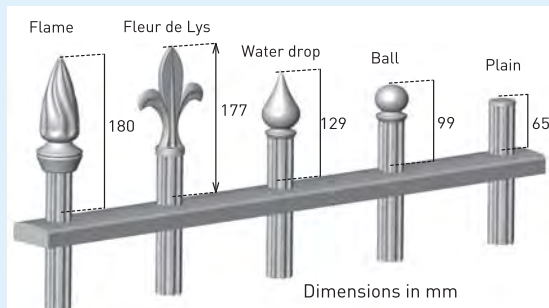

NESLIA - SWING GATES



MYOSOTIS - RAILINGS

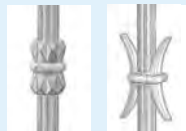

EXAMPLES OF POSSIBLE VARIATIONS



QUILLOR - SWING GATES

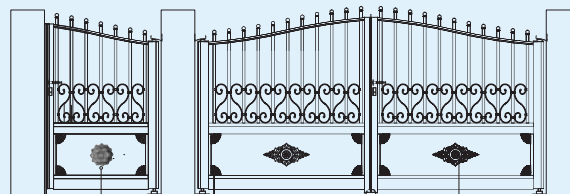

Rosette

Quarter rosette

Palmette



IRIS - SWING GATES

PALMETTES

Option available for Traditional gates with sheet metal base (except diamond base). These decorative designs are lacquered either the same colour of the gate or in matt gold finish (option).



VILLANDRY
700 x 380 mm



VENDÔME
385 x 195 mm



VENDÔME
385 x 195 mm



MARSULT - SWING GATES

ROSETTES AND QUARTER ROSETTES

Option available for Traditional gates with sheet metal base (except diamond base). These decorative designs are lacquered either the same colour of the gate or in matt gold finish (option).



AMBOISE Rosette
diameter: 170 mm



CHINON Rosette
diameter: 110 mm



FONTAINEBLEAU Rosette
diameter: 95 mm



BLOIS Rosette
diameter: 65 mm



AMBOISE Rosette matt gold
finish (option)



AMBOISE
Quarter rosette

ANODISED

ANODISED Collection

With many models available, this sleek & modern collection allows you to create your own design of gate whilst taking inspiration from the range on offer. All Anodised boards are visible on both sides of the gate with a range of paint finishes available.



TOSKA- SLIDING GATE

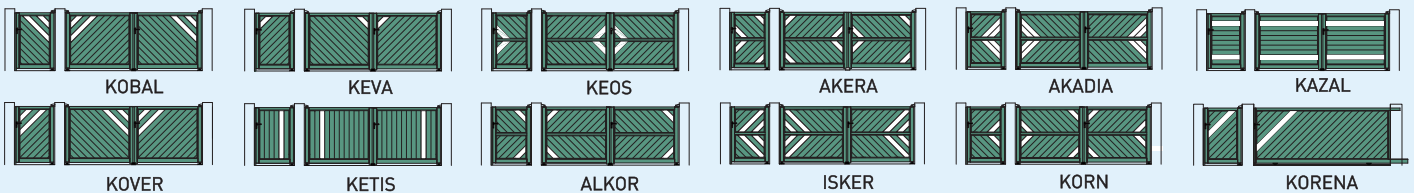

MANY MODELS AVAILABLE



AKADIA - SLIDING GATE

INTERIOR AND EXTERIOR DESIGN

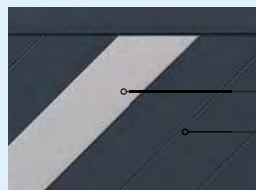

Anodised board
Gate in the colour of your choice

The Anodised finish is on the entire board, front / back.

This way, the integration of the boards in the construction of the gate provides a visible pattern on both sides.

CUSTOMISABLE DESIGN

You can create your own pattern, either by taking inspiration from the models in the range, or by starting from a blank page. Depending on your design the gate and fence can also be adapted. A prior technical validation will be carried out by our design office.



KANTUM - SLIDING GATE

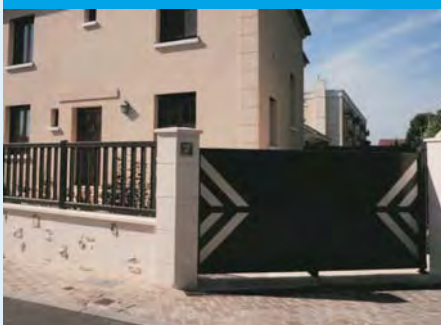

ISKER - SWING GATES



KAZAL - SWING GATES

WHAT IS ANODISATION?



Anodising is a surface treatment that brings an aesthetic benefit by highlighting the metal aspect of aluminium. Our anodising is certified by the quality label QUALANOD which guarantees in particular the density of the anodising layer and the resistance to corrosion.

The warranty period is identical to that of our woodgrain finish.

AKORDIA

AKORDIA Collection

This unique & stylish collection is available with standard 125mm boards and optional 250mm boards, a number of models with variation of opaque glass, brushes stainless steel or mirrored stainless steel inserts to give a personalised feel to your gates.



COTIM 11 - Swing gates



The AKORDIA range of gates are available in swing and sliding versions, flat top only. The decorative inserts are double-sided (inside and outside). A simplified version is available with 1 sided decorative inserts (outside only)

ANTALYA

Model with brushed stainless steel facings and white translucent glazing



ANTALYA
Swing version M1
with wide boards of 250 x 25 mm

COTIM 11

Model with horizontal aluminium inlaid decorations. 2 finishes: mirror or brushed stainless steel finish.



COTIM 11
Swing Gate version M1
with wide boards of 250 x 25 mm

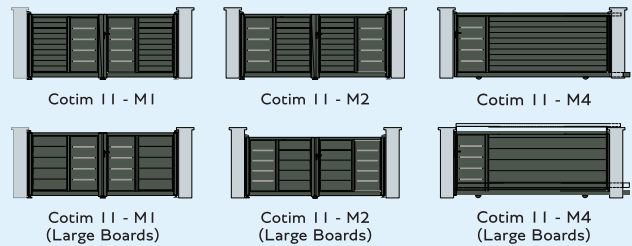
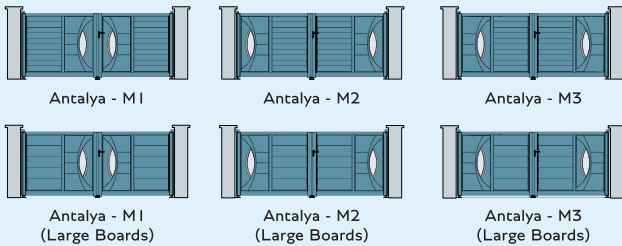

COTIM 39

Model with brushed stainless steel facings



COTIM 39
Swing Gate version M1
with standard blades of 125 x 25 mm

ATLANTIDE

Model with brushed stainless steel facings and white translucent glazing



ATLANTIDE
Swing Gate version M2
with standard boards of 125 x 25 mm

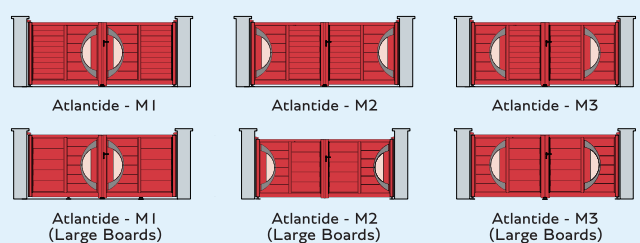
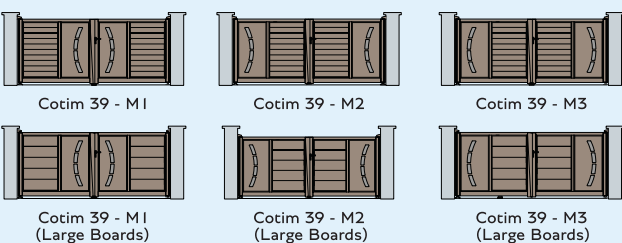

STAINLESS

STAINLESS *Collection*

This range of gates with a modern style is characterised by the use of brushed stainless steel inserts, fixed on both sides of the gate (inside and out). The modern, stylish design of these gates are offered in several different variants and a wide range of colours.



SENSO 4 - SLIDING GATE

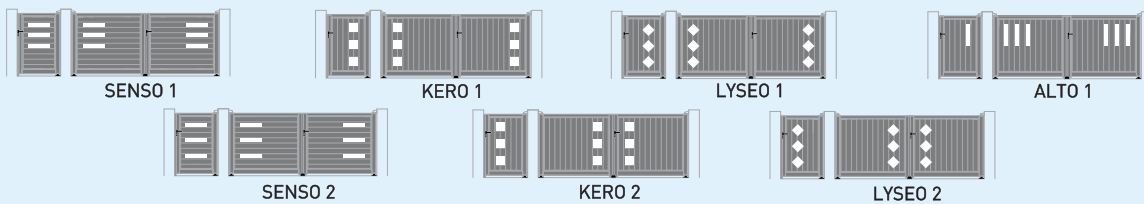

KERO 4 - SLIDING GATE

INTERIOR AND EXTERIOR DESIGN

Stainless steel inserts are fitted to both sides of the gate, symmetrically. For example, for the KERO 1 there are 12 stainless steel inserts in total (6 on the outside and 6 on the inside).

The inserts are fixed on the gate slats and screwed to each other by stainless steel screws.

The screws are visible on the inside (3 or 4 screws per insert depending on the design). Using screws guarantees a permanent fixture of the inserts over the years.

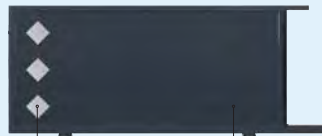

Brushed stainless steel inserts

Gate in the colour of your choice



SENSO 4 - SLIDING GATE



ALTO 1 - SWING GATES

The stainless steel inserts are quality 316 L brushed stainless steel finish, 2 mm thick. Stainless inserts are not guaranteed for installations within 1 km of marine coasts.

Insert dimensions:

- Square inserts KERO model: 20 x 20 cm
- Diamond inserts LYSEO model: 20 x 20 cm (diagonals of 28 cm)
- Inserts ALTO and SENSO models: 7.5 x 50 cm (placed vertically or horizontally)



KERO 1 - SWING GATES

REVELATION

REVELATION *Collection*

This collection offers many different options in order to create your own individual design. With bar, mesh & glass infills in a wide choice of colours, you can "mix & match" so many different components to create your perfect gate.



ALTAR 4 - SLIDING GATE



ALGA 4 - SLIDING GATE



TERA 2 - SLIDING GATE



ALGA 3 - SWING GATES



ALGA 1 - SLIDING GATE

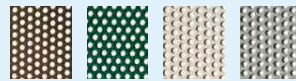

KAJAM 1 - SWING GATES



ALGA 1 - SLIDING GATE



ALGA 1 - SWING GATES

CONFIDENCE

CONFIDENCE *Collection*

Offering a completely different look & feel to our other collections, a selection of murals bring a touch of originality & elegance to suit the most discerning customer.

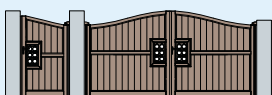

GARANCE



PROVIDENCE with 45° Boards

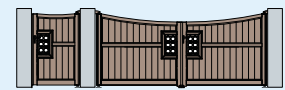

CLÉMENCE

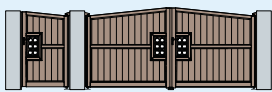

PRÉSENCE

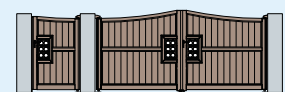

PROVIDENCE



CONFIANCE



JOUVENCE

CONFIDENCE

The range includes 7 models of swing gates and associated pedestrian gates.



GARANCE - SWING GATES



CIRCLES



CROSSES



DIAMONDS



GARANCE - SWING GATES

The inserts can be painted in a different colour from that of the gate (no extra charge for standard colours)

NIGHT & DAY®

NIGHT & DAY Collection

The Night & Day Gates are equipped with a high quality LED lighting system. With your smartphone or tablet you can control and customise your lighting to the way you want it. You can also choose between several designs all obtained by laser cutting into Alunox brushed stainless steel panels.



CLAW



BUBBLES



REEDS



MAZE



SUN



NIGHT & DAY with "Claw" design and 250mm boards

Control your LEDs and organise your colours by Smartphone or Tablet

'Premium Light' version with wi-fi controller, supplied with the system. You can connect your smartphone or tablet to your lighting by downloading the appropriate application* You will then have access to an unlimited choice of colours that you can select and change at any time.

*Application compatible with IOS and Android systems.

SINGLE LIGHT VERSION

The 3 colours: White, Blue, Red



MOON



LINES



SQUARES



MOSAIC



WAVES

LAZER

LAZER Collection

The LAZER range offers a series of 11 styles specifically designed for the collection and created by laser cutting of aluminium sheet. Most patterns are available in 2 formats, vertical or horizontal, and can be integrated with 4 gate models (MUZE, IZIS, MEZZO and OZ) to create a set of 30 variations available in hinged or sliding versions. A collection that combines design and originality.



MUSE - Natura



IZIS - Courbes



MUSE - Tropique



IZIS - Courbes



IZIS - Austral



MUSE - Provence



IZIS - Zebra



Coup de vent



Courbes



Natura



Austral



Lauze



Provence



Rythme



Samba



Variations



Tropique



Zebra



IZIS

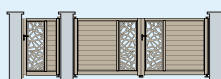

MEZZO

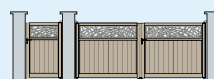

MUZE



OZ

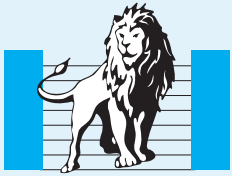

PORTALIERS®

in agreement with **horizAL**

As a registered UK HorizAL "Portaliere" for our area, we form a professional network of Gate Installers covering the UK to accommodate the demand for Aluminium gates & automation, as well as providing outstanding levels of service & support. "Portaliere" create a seamless link between HorizAL & our clients & we are extremely passionate about this world-class product, now sold in over 30 countries.

COLOUR OPTIONS

A WIDE RANGE OF SHADES, TEXTURED FINISHES OR SAND BLASTED OPTIONS ARE AVAILABLE AS BELOW:-

STANDARD COLOURS - Optional fine textured finish

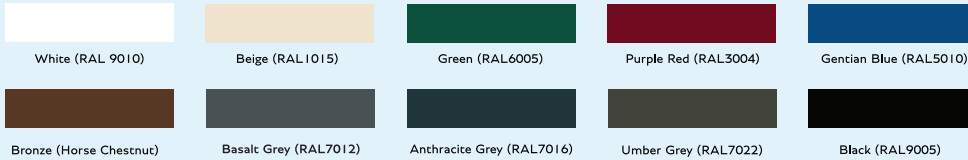

OPTIONAL - SHADES OF COLOUR - "EXPRESSION" RANGE: Selection of shades textured finish

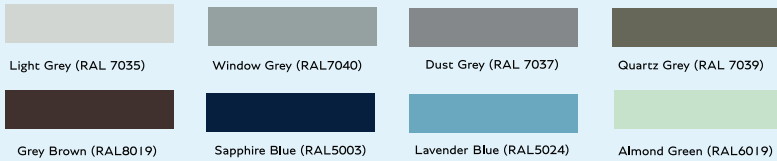

OPTIONAL - SHADES OF COLOUR - "FUTURA" RANGE: Textured finish 'Sand Blasted'

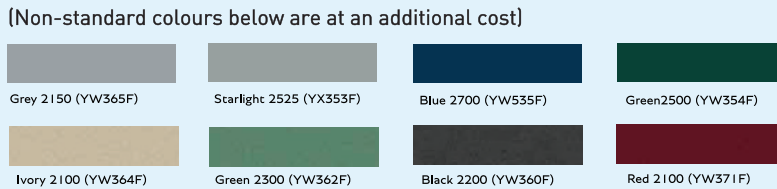

OPTIONAL - 'REAL WOOD EFFECT' - 5 REALISTIC WOOD EFFECTS ARE AVAILABLE - OUR REPRESENTATIVE HAS A SAMPLE BROCHURE WITH TEXTURED OPTIONS

(Woodgrain effects at additional cost)

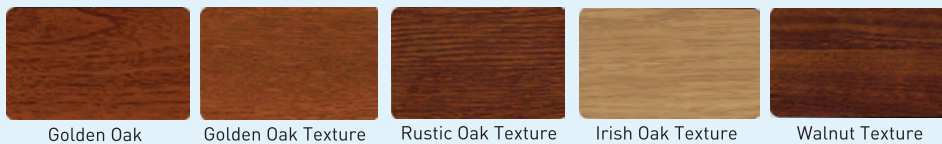

"Why HorizAL Aluminium Gates"

Fantastic designs to enhance the look and feel of all traditional and modern builds. Wide range available with many personalised solutions to meet your requirements. Fully CE Marked.

Designed with the possibility of dismantling and replacing sections or items in the event of damage.

All products are subject to a rigorous QC system and factory-tested prior to despatch.

Manufactured to the highest possible standard, complete with heavy duty extruded framework, infill panels and reinforcement for automation, fully guaranteed for **5 years**.

Virtually maintenance free, unlike steel and wooden gates which require continuous upkeep, such as rust protection, painting or staining.

All products are finished and protected with an internationally recognised process called "Qualicoat", offering a robust outer coating, guaranteed for **10 years**.

"Quality isn't expensive, it's priceless!"

Extruded aluminium sections for extra strength



Reinforcement for automation

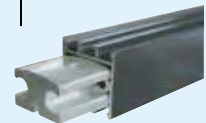

STANDARD INFILLS

25 x 22 mm

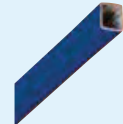

45 x 22 mm



100 x 22 mm

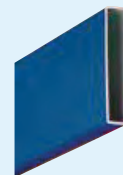

OPTIONS

80 x 22 mm



120 x 22 mm



Live Wire Gates & Doors
Arlaw Banks
Winston, Darlington
DL2 3PX
Tel. No. 01833 627776
Email: livewiregates@horizal.co.uk
Web: www.horizal.co.uk/livewiregates